

USB

CPU

GPS

AC97

ETHERNET_A

ADC

ETHERNET_B

ETHERNET_C

GPIO

ETHERNET_D

DC/DC

RCS/LED

Design	Description	Included in	Machine
△	TOP	Release ECO	Release date 02/11/09
△	Drawn	Replaces	Design rev.
△	Checked	Drawing no.	Page
△			
△			
△			
△			
△			
△			
△			
△			
△			
△			
△			

ORSoc

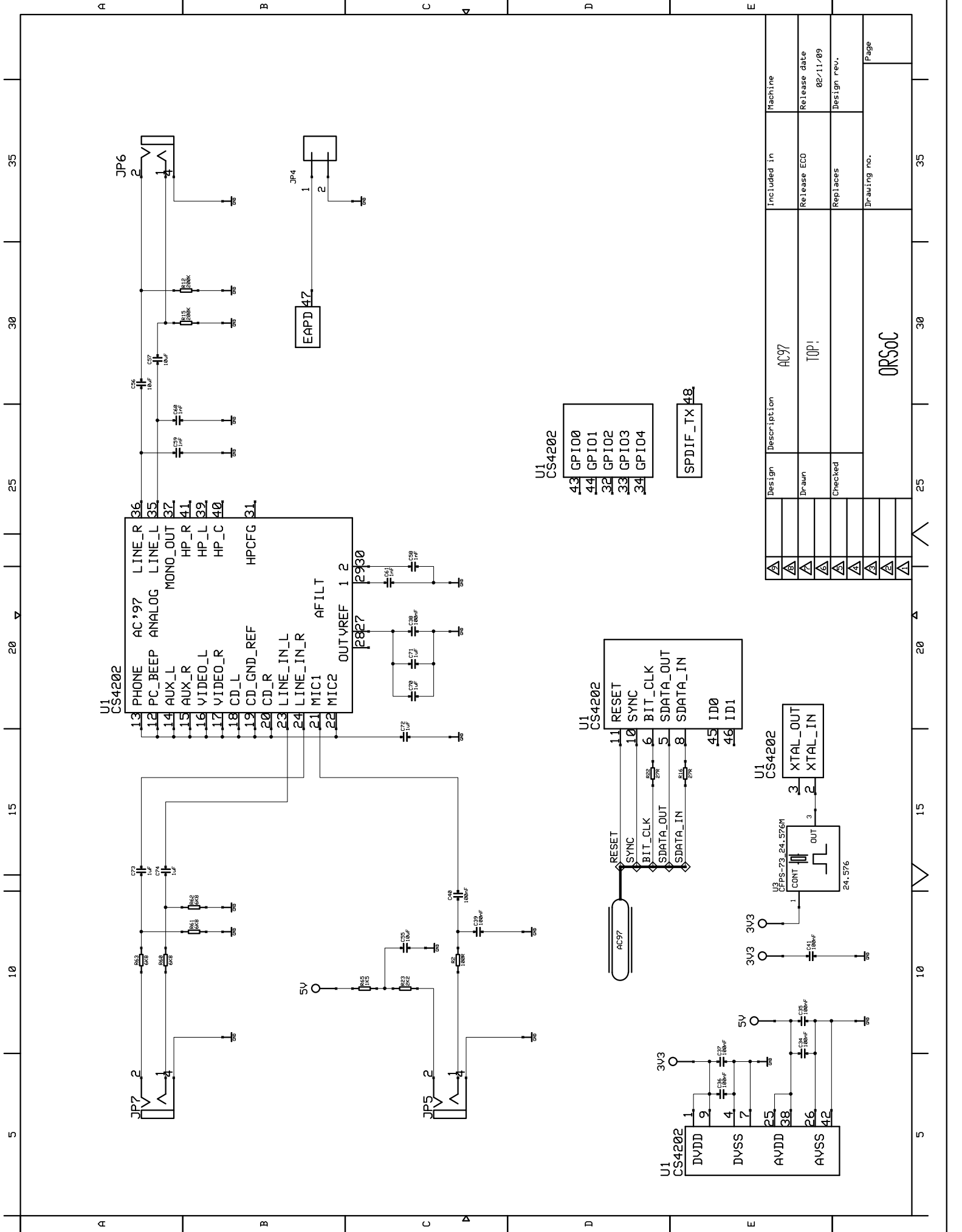

- U1 CS4202
- 43 GPI00
 - 44 GPI01
 - 32 GPI02
 - 33 GPI03
 - 34 GPI04

SPDIF_TX 4B

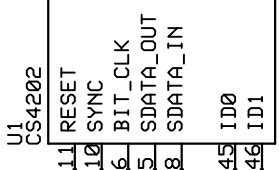

- U1 CS4202
- 11 RESET
 - 10 SYNC
 - 6 BIT_CLK
 - 5 SDATA_OUT
 - 8 SDATA_IN
 - 45 ID0
 - 46 ID1

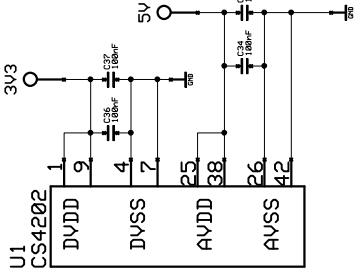
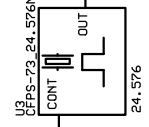
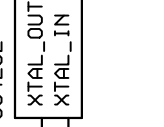

Design	Description	Included in	Machine
AC37	AC37	Release ECO	Release date
TOP!	TOP!	Replaces	02/11/09
Checked		Drawing no.	Design rev.
			Page

ORSoC

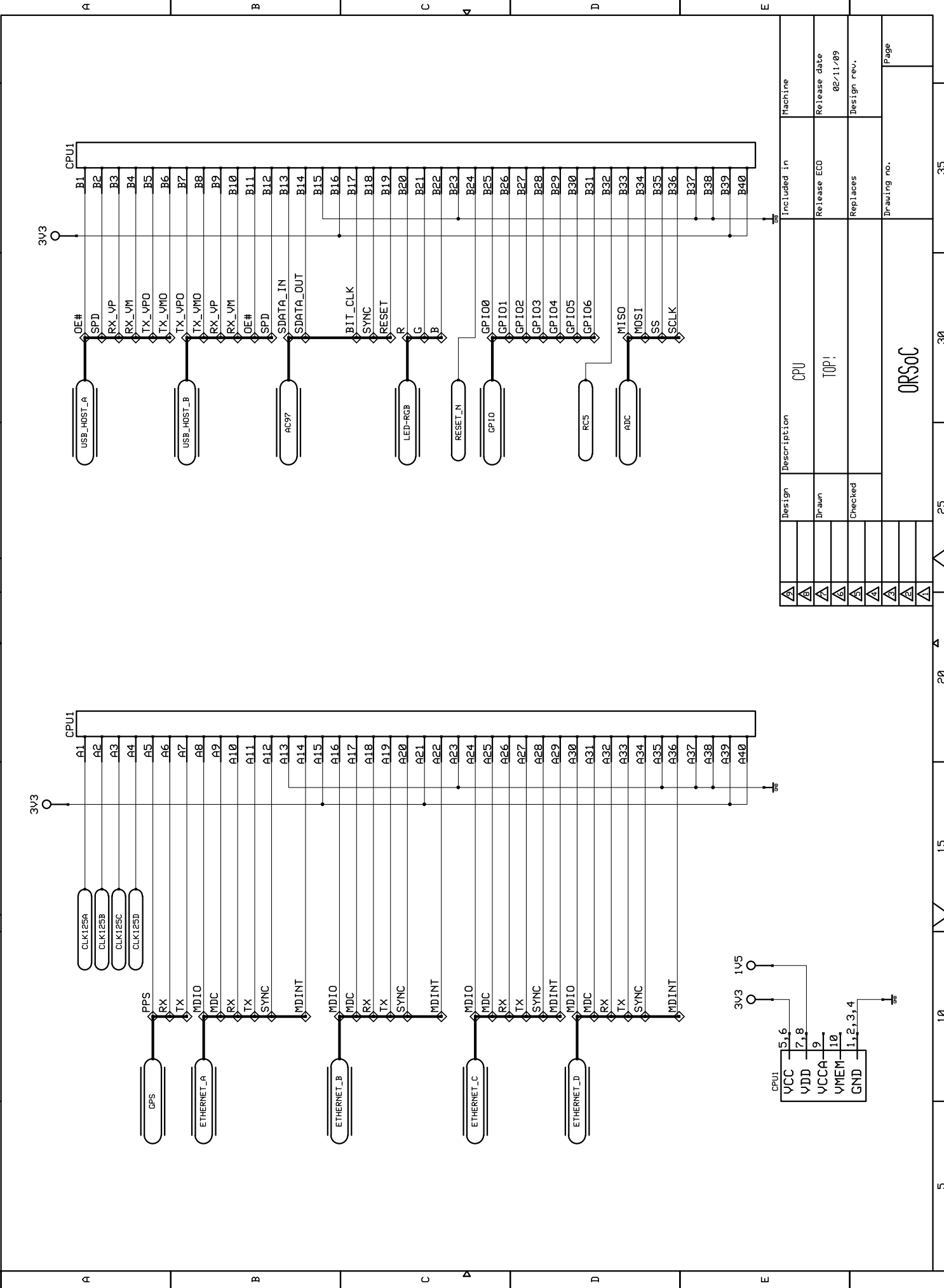

Design	Description	Included in	Machine
▲	CPU	CPU	
▲	Drawn	TOP!	Release ECO
▲	Checked		Release date
▲			02/11/09
▲			Replaces
▲			Design rev.
▲			Drawing no.
▲			Page

5 10 15 20 25 30 35

A B C D E

35 30 25 20 15 10 5

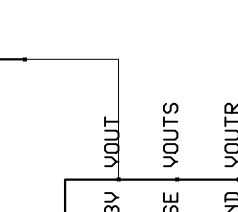
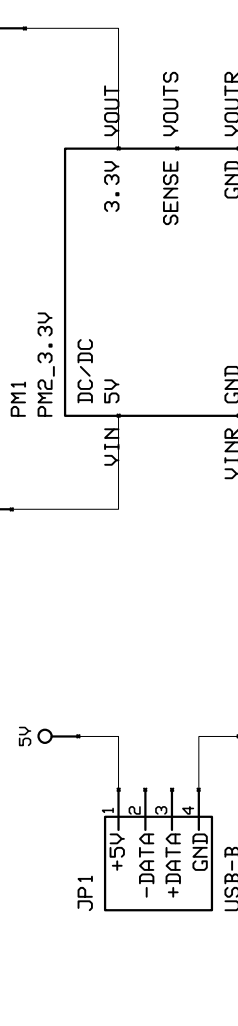
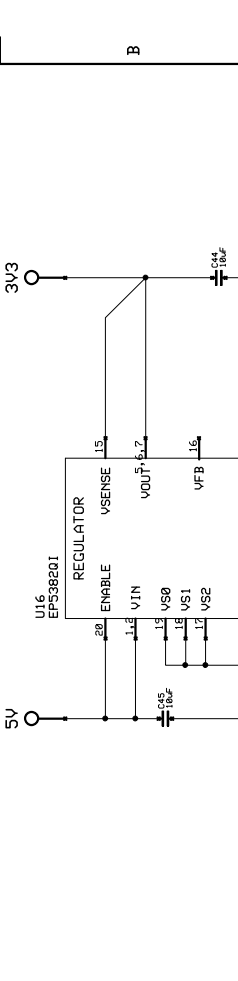
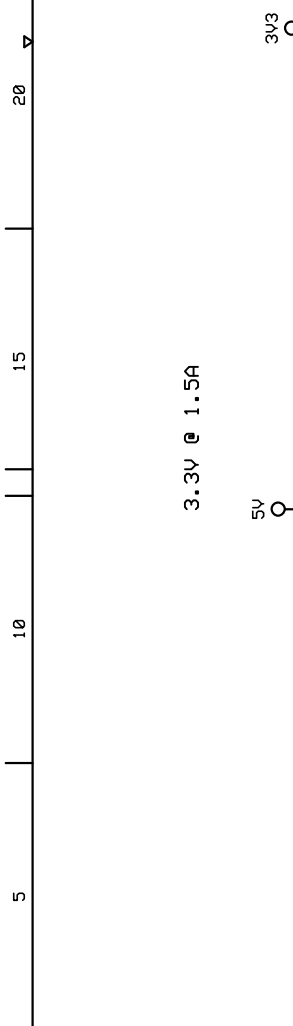
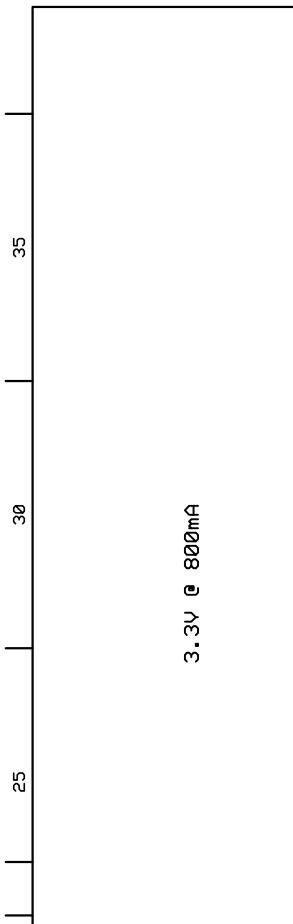
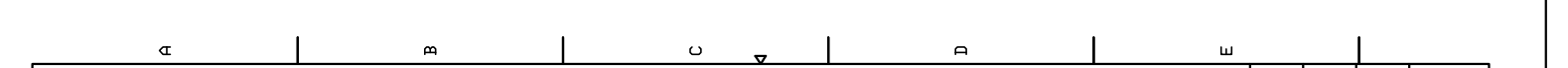

Design	Description	Included in	Machine
Design	DC/DC		
Drawn	TOP!	Release ECO	Release date 02/11/09
Checked		Replaces	Design rev.
		Drawing no.	Page
ORSoc			



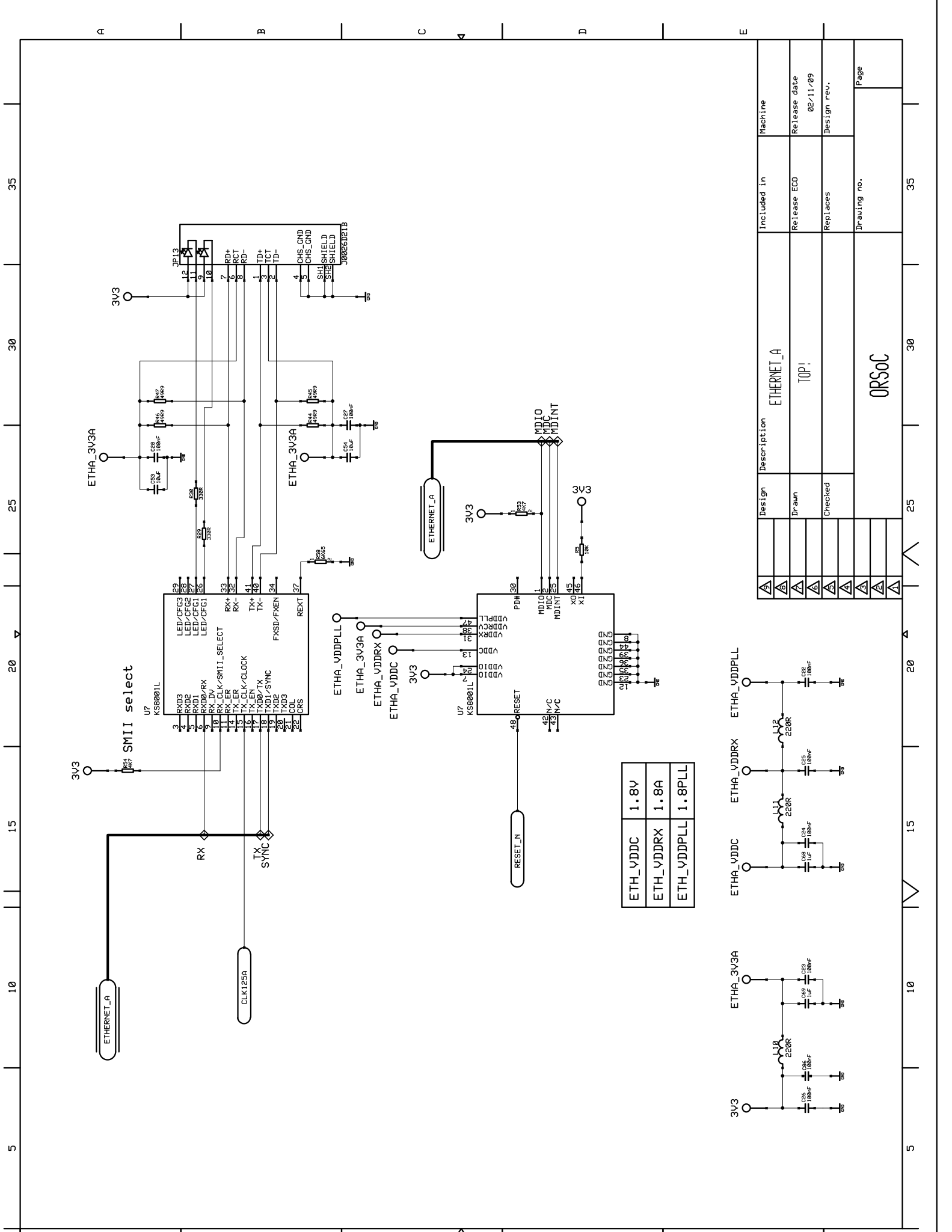

ETH_VDDC	1.8V
ETH_VDDR	1.8A
ETH_VDDPLL	1.8PLL

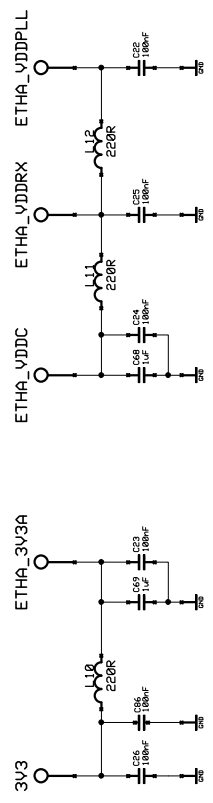

Design	Description	Included in	Machine
Drawn	ETHERNET_A	Release ECO	Release date
Checked	TOP!	Replaces	02/11/09
		Drawing no.	Design rev.
			Page

ORSoC

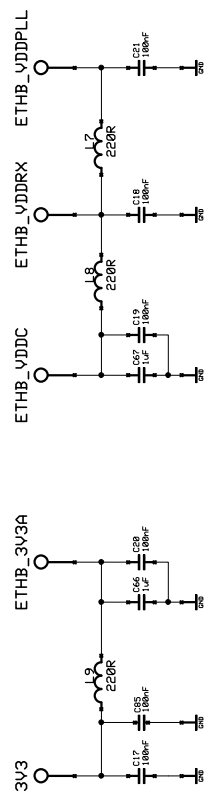
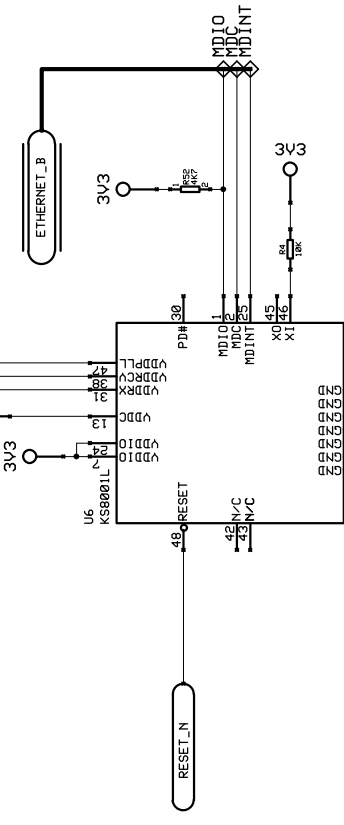
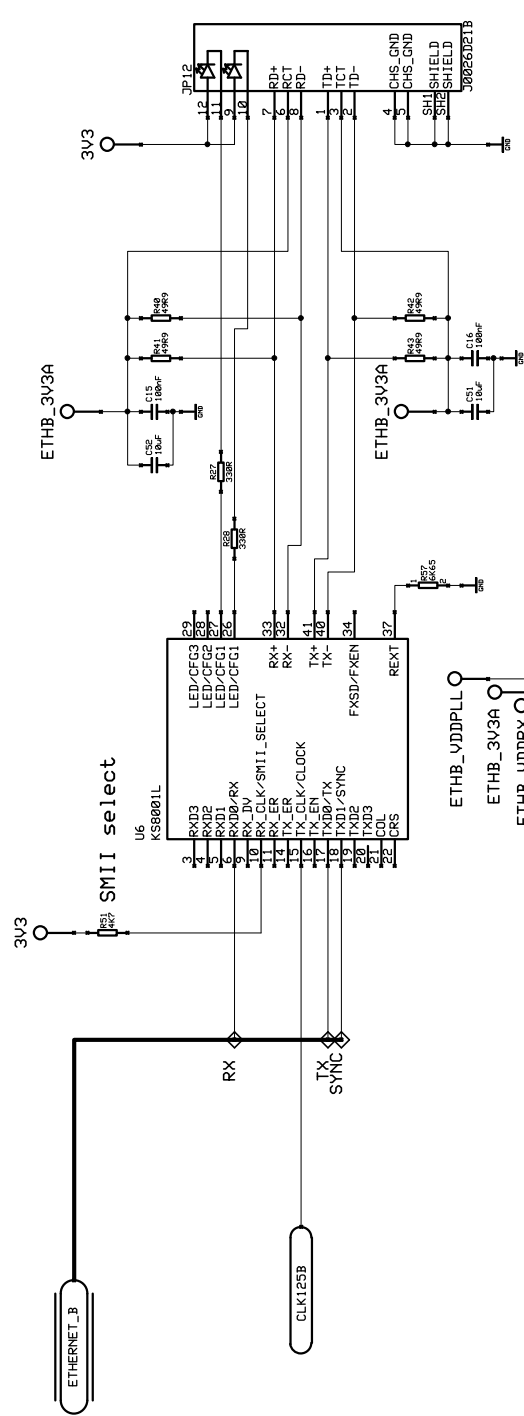

Design	Description	Included in	Machine
Drawn	ETHERNET_B TOP!	Release ECO	Release date 02/11/09
Checked		Replaces	Design rev.
		Drawing no.	Page

ORSoC

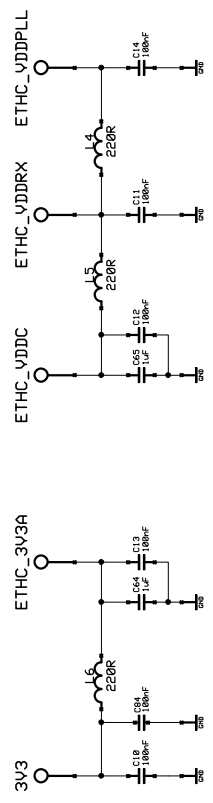
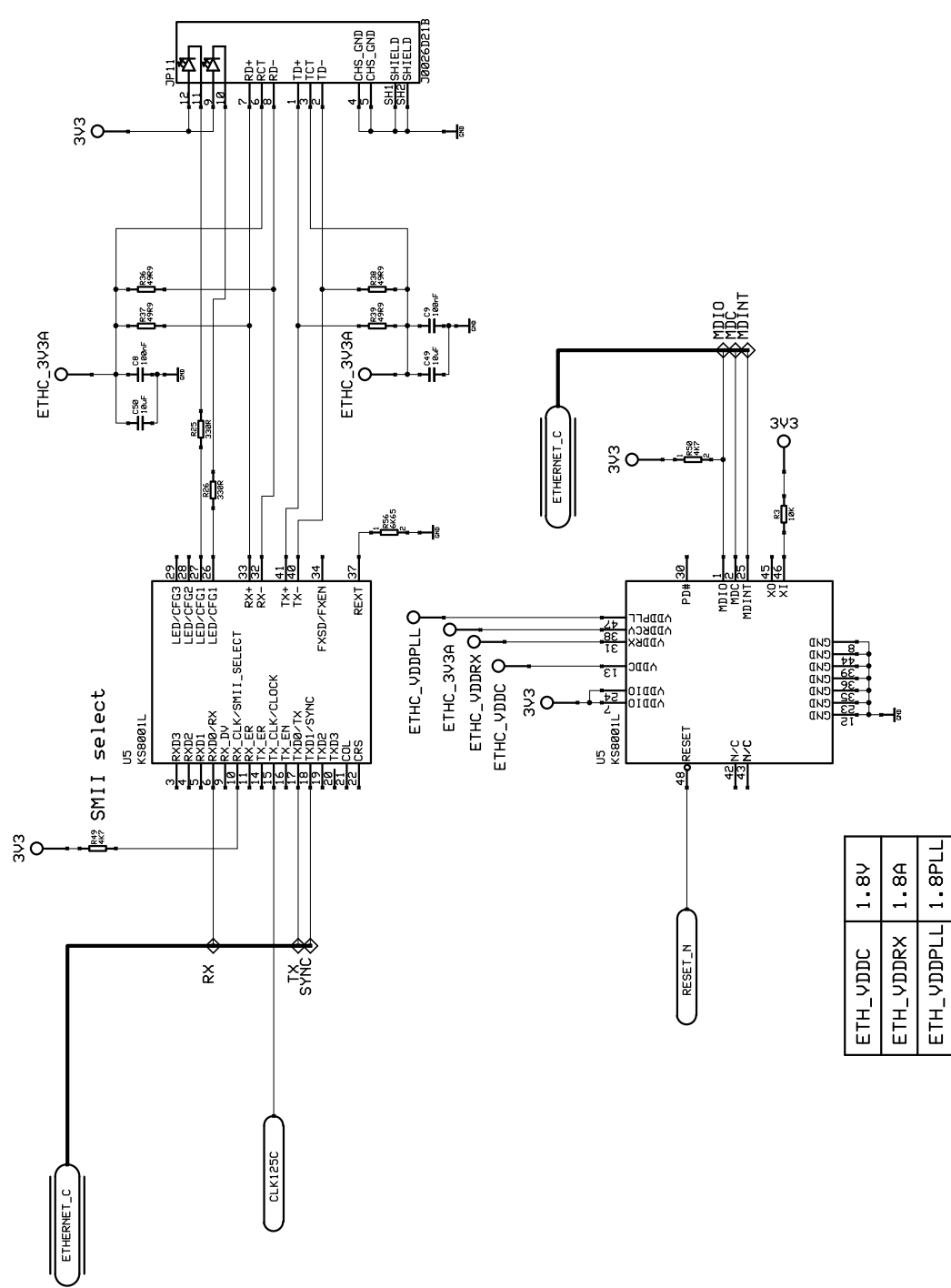

Design	Description	Included in	Machine
Drawn	ETHERNET_C TOP!	Release ECO	Release date 02/11/09
Checked		Replaces	Design rev.
		Drawing no.	Page

ORSoC

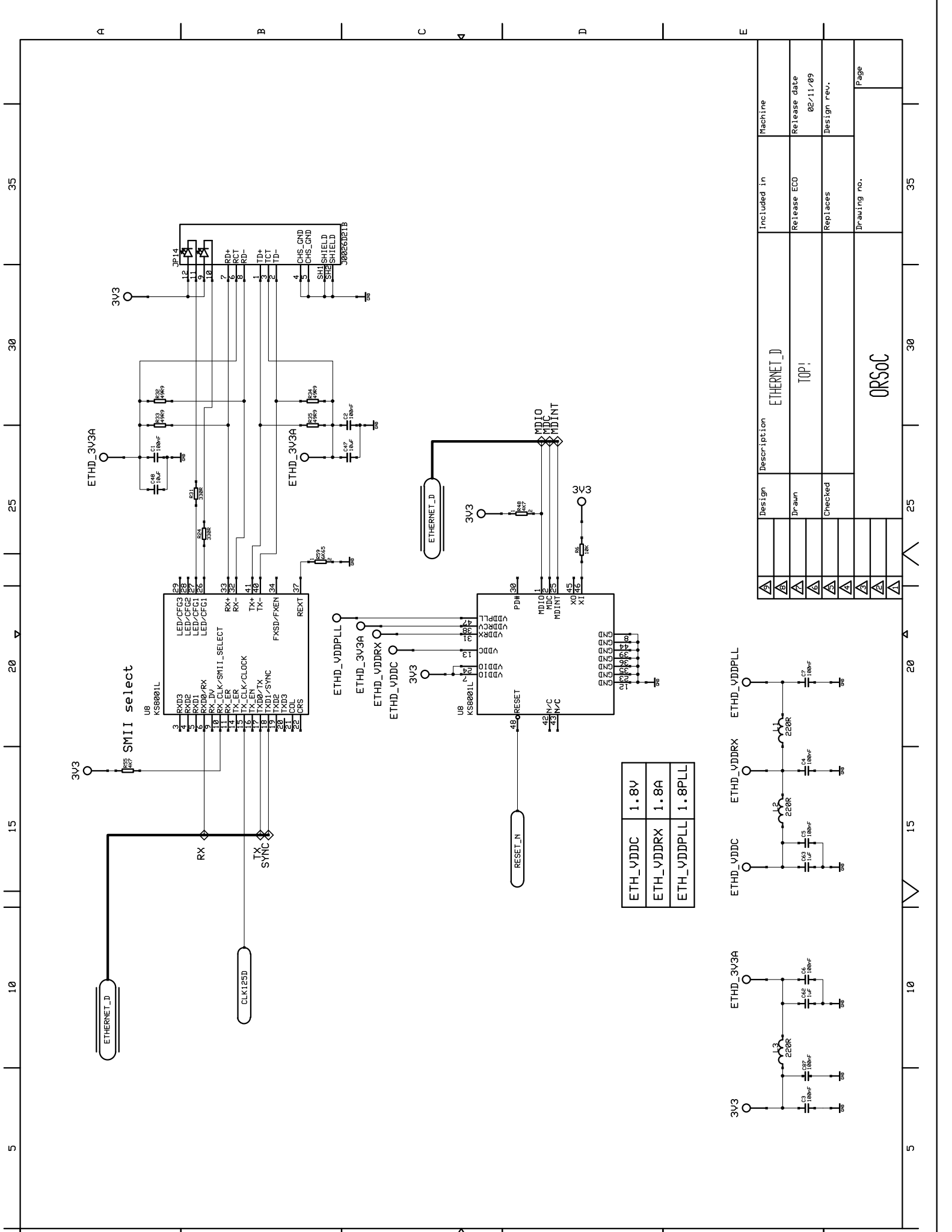

ETH_VDDC	1.8V
ETH_VDDRX	1.8A
ETH_VDDPLL	1.8PLL

Design	Description	Included in	Machine
Drawn	ETHERNET_D TOP!	Release ECO	Release date 02/11/09
Checked		Replaces	Design rev.
		Drawing no.	Page

OR50C

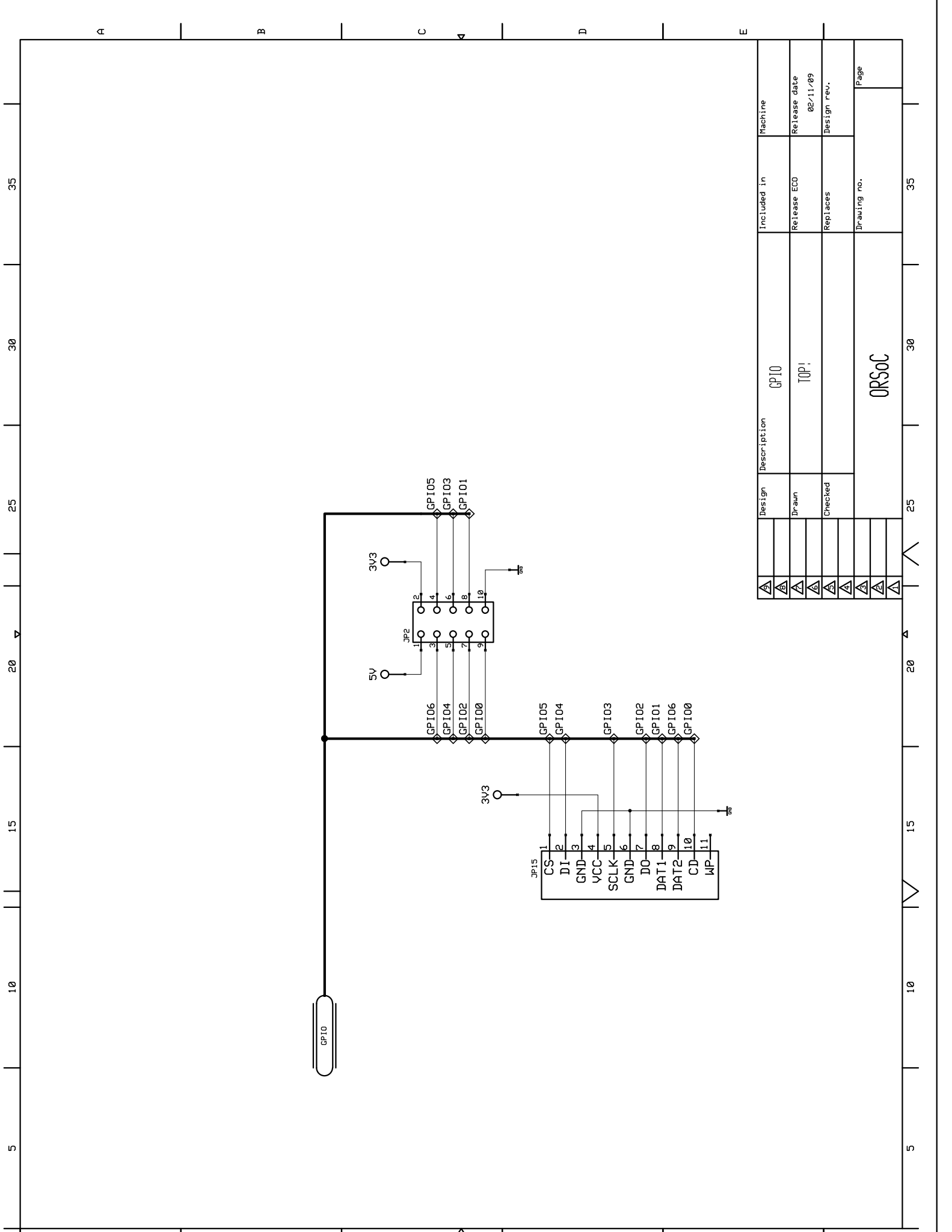

5 10 15 20 25 30 35

A B C D E

Design	Description	Included in	Machine
Drawn	GP10 TOP!	Release ECO	Release date 02/11/09
Checked		Replaces	Design rev.
		Drawing no.	Page

OR50C

5 10 15 20 25 30 35

A B C D E

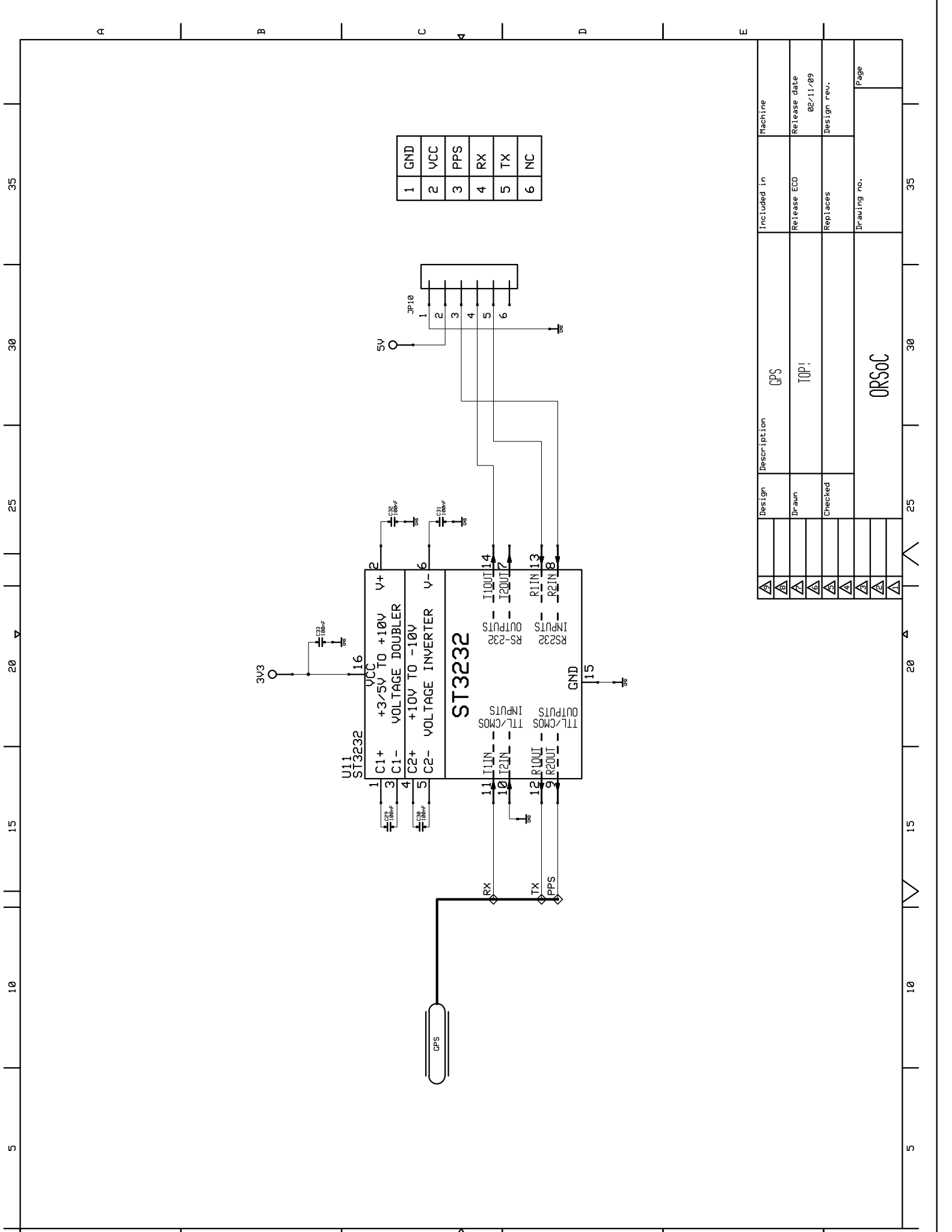

1	GND
2	VCC
3	PPS
4	RX
5	TX
6	NC

Design	Description	Included in	Machine
Design	GPS	Release ECO	Release date
Drawn	TOP!	Replaces	02/11/09
Checked		Drawing no.	Design rev.
			Page

ORSoC

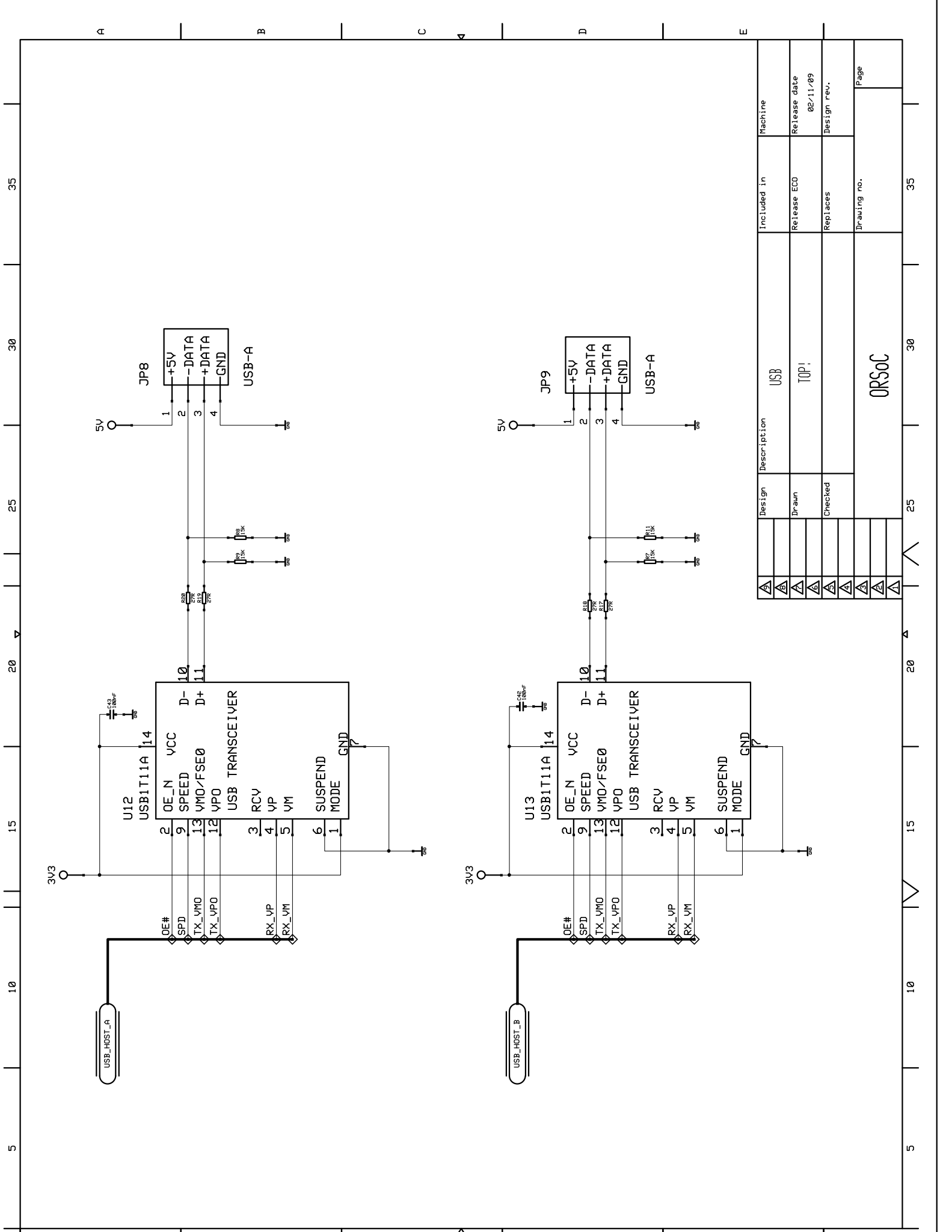

Design	Description	Included in	Machine
Drawn	USB	Release ECO	Release date
Checked	TOP!	Replaces	02/11/09
		Drawing no.	Design rev.
			Page
ORSOC			